

# Stainless Steel Kitchen Sink

SKU: CH6045.KS

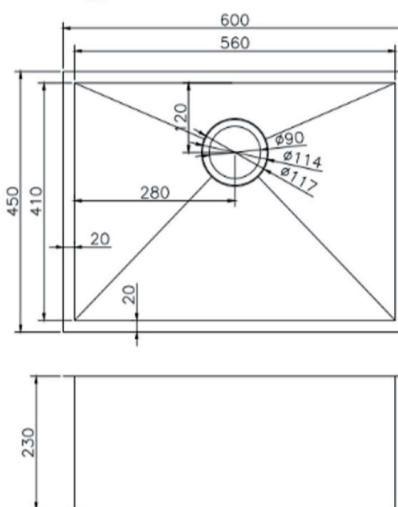

www.aquaperla.com.au

## SPECIFICATION

Color Availability: Chrome

Material: Stainless Steel

Dimension: 600mmL x 450mmW x 230mmH

Weight: 11.00KG

Package Size: 660\*510\*380 mm

Spec.: Stainless Steel Kitchen Sink

Installation: Drop-in / Top / Flush / Under-mount

## Instructions for Top Mounted Sinks

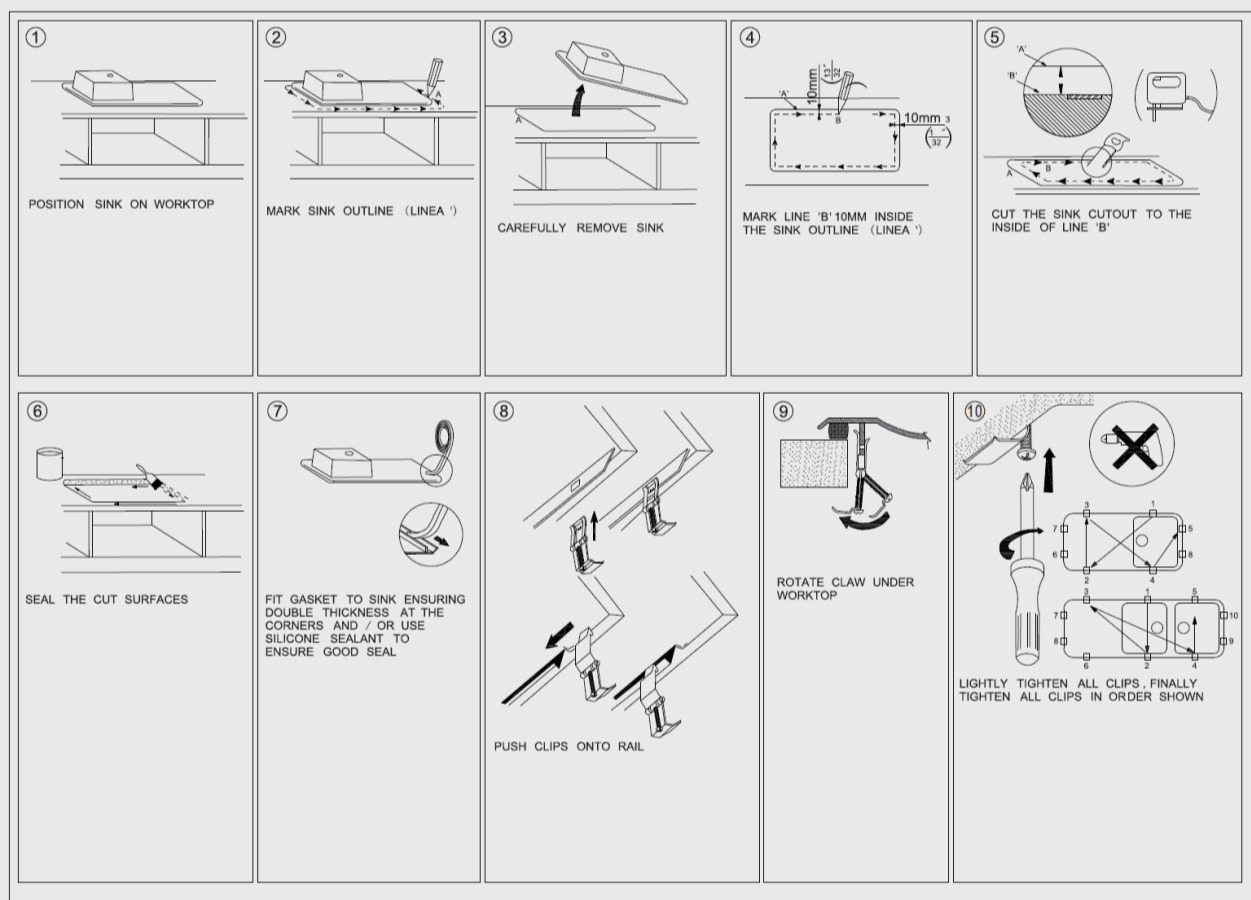

## Instructions for Under Mounted Sinks

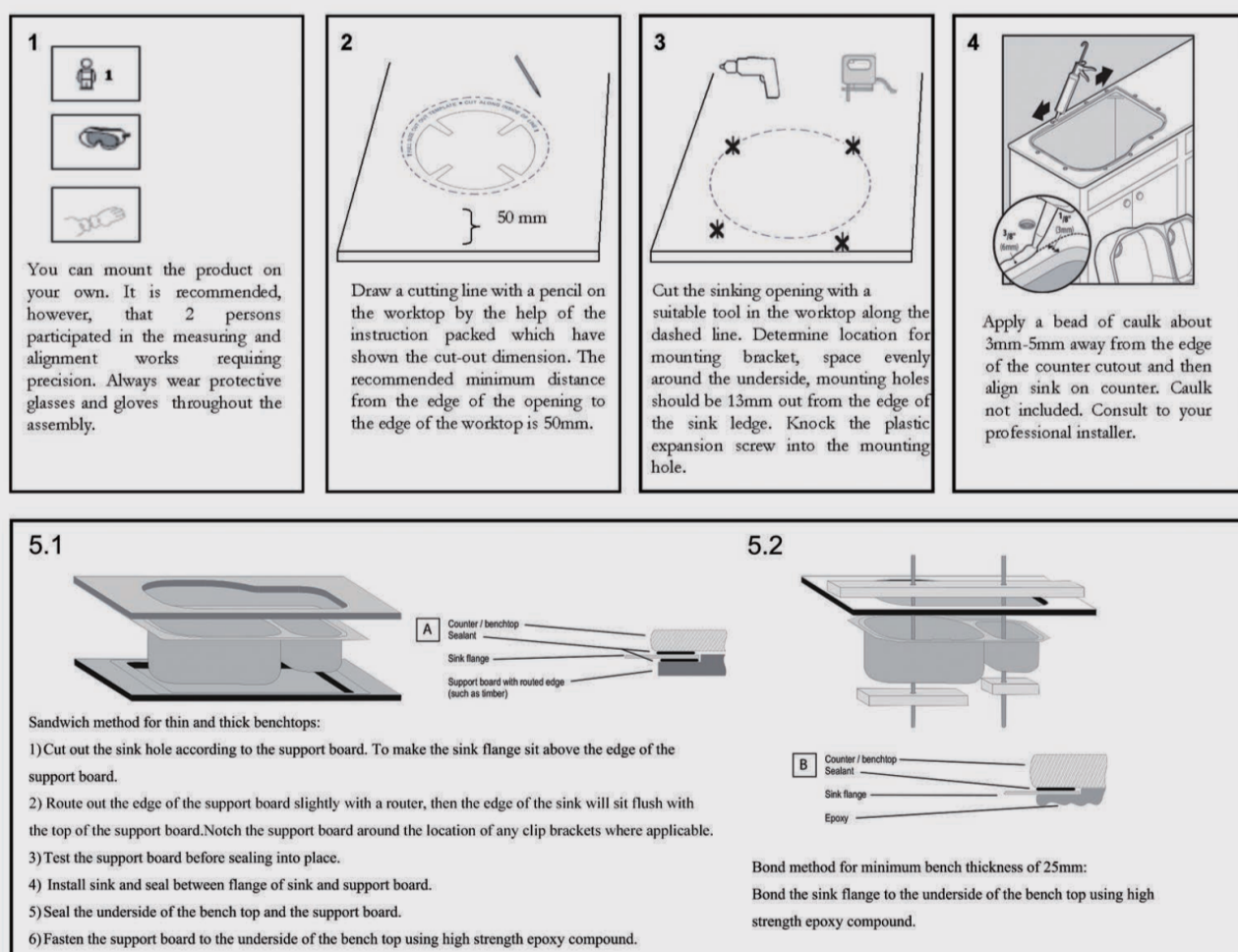

## CLEANING RECOMMENDATIONS

This product should not be cleaned with abrasive materials. Damage caused by any improper treatment is not covered by the product warranty - refer to Warranty Conditions on our website: [www.aquaperla.com.au](http://www.aquaperla.com.au)

Disclaimer: Products in this specification manual must by regulation, be installed by licensed and registered trade people. The manufacturer/ distributor reserves the right to vary specifications or delete models from their range without prior notification. Dimensions are nominal measurements only. Dimensions and set-outs listed are correct at time of publication however the manufacturer/ distributor takes no responsibility for printing errors.